

GNS-12012Ax-Bx (SINGLE DIGIT LED DISPLAY)

GNS-12012 Series

GNS-12012Ax

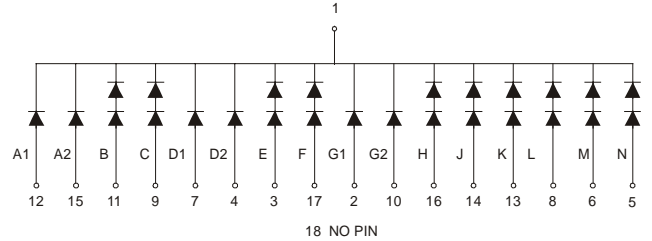
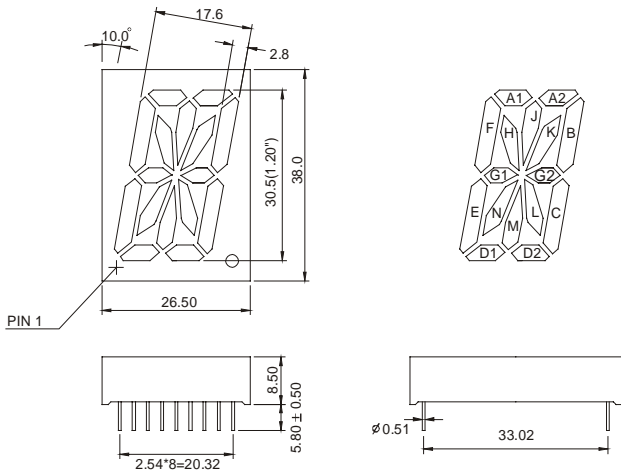

GNS-12012Bx

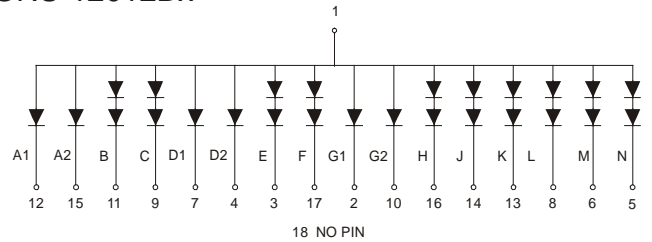

Features:

*1.2 INCH HIGH CHARACTER.

*EXCELLENT CHARACTER APPEARANCE.

*COMMON CATHODE OR COMMON ANODE.

*I.C. COMPATIBLE

*LOW POWER CONSUMPTION.

Part Number	EMITTED COLOR		Common Cathode or Common Anode	Peak Wavelength (nm)	Vf (v) Typ	If (mA)	Intensity Per Segment (mcd)	
							Min.	Typ.
GNS-12012AE	GaAsP/GaP	Hi.effi Red	Common Cathode	635	2.0	20	18	24
GNS-12012AG	GaP	Green		565	2.1	20	16	22
GNS-12012AY	GaAsP/GaP	Yellow		585	2.0	20	18	24
GNS-12012AS	GaAlAs	Super Red		660	1.8	20	20	26
GNS-12012AD	GaAlAs	Ultras Red		660	1.8	20	50	60
GNS-12012AUE	AlGaN	Ultra Red		625	2.0	20	60	70
GNS-12012AUY	AlGaN	Ultra Yellow		590	2.0	20	60	70
GNS-12012BE	GaAsP/GaP	Hi.effi Red	Common Anode	635	2.0	20	18	24
GNS-12012BG	Gap	Green		565	2.1	20	16	22
GNS-12012BY	GaAsP/GaP	Yellow		585	2.0	20	18	24
GNS-12012BS	GaAlAs	Super Red		660	1.8	20	20	26
GNS-12012BD	GaAlAs	Ultras Red		660	1.8	20	50	60
GNS-12012BUE	AlGaN	Ultra Red		625	2.0	20	60	70
GNS-12012BUY	AlGaN	Ultra Yellow		590	2.0	20	60	70