

GNL-5012xx (Φ 5mm ROUND TYPE) Standard Brightness

ABSOLUTE MAXIMUM RATING:(Ta=25°C)

Parameter			Unit
DC Forward Current	30		mA
Reverse Voltage	5		V
Reverse Current (Vr=5V)	10		μA
Peak Forward Current ,tw ,=1 msec Duty ,=1/20	150		mA
Operation Temperature	-40	+80	°C
Storage Temperature	-40	+100	°C
Solder Dip (5 seconds,1.6mm from body) Temperature	260	±5	°C

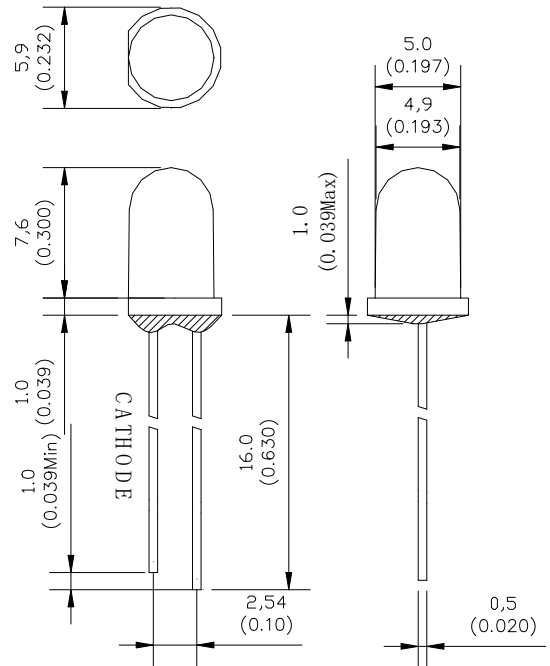

Feature:

- 1.Low power consumption
- 2.High efficiency and low cost
- 3.Versatile mounting on P.C.board or panel
- 4.Wide and narrow viewing angle
- 5.Long life sold state reliability

Description:

- 1.The shape of this series is round
- 2.General application is for indication,illumination,etc.
- 3.These LED lamps are available with a choice of defferent colors,light intensities,epoxy colors,etc.

Part Number	EMITTED COLOR		Lens Color	Peak Wavelength (nm)	Vf (v) Typ.	IV (If=20mA) mcd		View Angle 2 θ 1/2
						Min.	Typ.	
GNL-5012HD	GaP	Red	Red Diffused	700	2.1	0.8	3.0	60°
GNL-5012GD	GaP	Green	Green Diffused	565	2.1	3.0	8.0	60°
GNL-5012YD	GaAsP	Yellow	Yellow Diffused	585	2.1	3.0	7.0	60°
GNL-5012ED	GaAsP/GaP	Orange	Red Diffused	635	2.0	3.0	8.0	60°
GNL-5012ED-E	GaAsP/GaP	Orange	Orange Diffused	635	2.0	3.0	8.0	60°