

GNL-8003xx (Φ 8mm ROUND TYPE) Standard Brightness

ABSOLUTE MAXIMUM RATING:(Ta=25°C)

Parameter			Unit
DC Forward Current	30		mA
Reverse Voltage	5		V
Reverse Current (Vr=5V)	10		μA
Peak Forward Current ,tw ,=1 msec Duty ,=1/20	150		mA
Operation Temperature	-40	+80	°C
Storage Temperature	-40	+100	°C
Solder Dip (5 seconds,1.6mm from body) Temperature	260	±5	°C

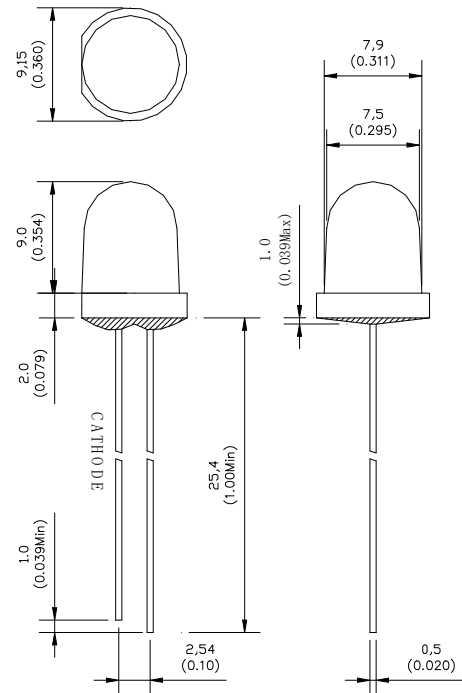

Feature:

- 1.Small flange without stand-off
- 2.Long life-solid state reliability
- 3.Long lead length(25.4mm)
- 4.Versatile mounting on P.C. board or panel

Description:

- 1.The shape of this series is round
- 2.General application is for indication,illumination,etc.
- 3.These LED lamps are available with a choice of defferent colors,light intensities,epoxy colors,etc.

Part Number	EMITTED COLOR		Lens Color	Peak Wavelength (nm)	Vf (v) Typ.	IV (If=20mA) mcd		View Angle 2 θ 1/2
						Min.	Typ.	
GNL-8003GD	GaP	Green	Green Diffused	565	2.1	5	15	60°
GNL-8003YD	GaAsP	Yellow	Yellow Diffused	590	2.1	5	15	60°
GNL-8003ED	GaAsP/GaP	Orange	Red Diffused	625	2.0	8	20	60°
GNL-8003ED-E	GaAsP/GaP	Orange	Orange Diffused	635	2.0	8	20	60°
GNL-8003GT	GaP	Green	Green Transparent	565	2.1	10	30	20°
GNL-8003YT	GaAsP	Yellow	Yellow Transparent	590	2.1	10	30	20°
GNL-8003ET	GaAsP/GaP	Orange	Red Transparent	635	2.0	25	60	20°
GNL-8003ET-E	GaAsP/GaP	Orange	Orange Transparent	635	2.0	25	60	20°